



221 Weaver Street, Fall River, MA 02720
Tel# 508-676-7345 • 800-879-7918 • Fax# 508-676-7346
www.hbcontrols.com

TP SERIES USERS MANUAL

SSR INTELLIGENT BURST FIRING CONTROL



TABLE OF CONTENTS

1. Ordering Codes 2

2. Description..... 2

 2.1 Features..... 3

3. Installation 3

 3.1 Mounting Instructions..... 3

 3.2 Electrical Connections 3

4. Operation..... 3

 4.1 Power Supply..... 3

 4.2 24V Power Fusing 4

 4.3 Command Input 4

 4.3.1 Input Fail-safe Protection 4

 4.4 Cycle Times 4

 4.5 Power Limit 4

 4.5.1 Power Limit Adjustment Procedure 4

 4.6 Configuration Dipswitch..... 5

 4.7 Control Output 5

 4.8 Output LED 6

 4.9 Three Phase Operation 6

 4.9.1 Three Phase Operation – Cycle Times..... 6

 4.10 Wiring Multiple Units..... 6

 4.10.1 Connecting Power & Commands In Parallel..... 7

5. Electrical Specifications..... 7

6. Mechanical Dimensions 7

7. Contact Information 7

8. WIRING DIAGRAM (4-20mA, 0-5V, 0-10V Inputs)..... 8

9. WIRING DIAGRAM (Potentiometer Input) 8

10. WIRING DIAGRAM (0-135 Ohm Input) 9

11. WIRING DIAGRAM 3 PHASE DELTA CONNECTION 9

12. WIRING DIAGRAM 3 PHASE WYE 10

1. Ordering Codes

Part#	Description	Inputs
TP	SSR Mount Burst Firing Control Module, Volts, mA Input, Pot	0-10V, 0-5V, 2-10V, 1-5V, 4-20mA, 0-20mA, Potentiometer
TP135	SSR Mount Burst Firing Control Module, 0-135Ω Input, 24VAC Power Only	0-135Ω
TPREV	Reverse Acting Output Option	0-10V, 0-5V, 2-10V, 1-5V, 4-20mA, 0-20mA, Potentiometer
TPPL	SSR Mount Burst Firing Control with power limit option, 24VAC Power Only	0-10V, 0-5V, 2-10V, 1-5V, 4-20mA, 0-20mA, Potentiometer

2. Description

The TP is a burst firing control module designed for use with standard footprint zero cross or random fire SSRs (Solid State Relays). The module mounts directly on the SSRs input screws. The module operates by varying duty cycle of SSRs control input. The power delivered to the load is proportional to the command input signal.

2.1 Features

- Command input accepts 4-20mA, 0-10V, 0-5V, 0-135 Ω , Potentiometer
- Configurable for 4 different cycle times
- Drives multiple solid state relays (SSRs)
- Small (1.75x1.40") module mounts on the input terminals of an inexpensive SSR
- Fits under finger-safe covers
- LED output indicator
- Adjustable Power Limit (-PL) Option
- Single phase and three phase control

3. Installation



WARNING: FIRE HAZARD!! Even quality electronic components **CAN FAIL KEEPING FULL POWER ON!** Provide a **SEPARATE (redundant) OVER TEMPERATURE SHUTDOWN DEVICE** to switch the power off if safe temperatures are exceeded.



WARNING: HIGH VOLTAGE!! This control is installed on a Solid State Relay with high voltage on it. This control must be installed in a **GROUND**ED enclosure by a qualified electrician in accordance with applicable local and national codes including NEC and other applicable codes. Provide a safety interlock on the door to remove power before gaining access to the device.

3.1 Mounting Instructions

The TP mounts directly to the control input terminals of an SSR. Some relays have short input screws and longer screws will be required to reach through the contacts on the SSRMAN. Be sure to observe the correct polarity when mounting the module (module should be positioned over the SSR). The module should sit firmly on top of the SSR when the screws are tightened.

3.2 Electrical Connections

See the **WIRING DIAGRAMS** at the end of this document. Make sure the module ordered is the correct module for the application before wiring.

Before wiring the module all Dip Switch settings for the command input and special features should be setup properly per the Dipswitch Configuration Section

4. Operation

4.1 Power Supply

The TP power requirement is 24V AC +/-15% 47-63Hz, 24VDC +30/-10%.

4.2 24V Power Fusing

Fusing may be accomplished by fusing each module separately or fusing groups of the modules with either primary or secondary fusing. The current draw of each TP is 65mA max.

4.3 Command Input

The TP can accept 4-20mA, 0-10V, 0-5V, and Potentiometer. The TP-135 can only accept a 0-135 Ω Input, and must be used with 24VAC Power. All command inputs are not isolated from the 24V power input; they share a common ground. The type of command input can be configured via the dipswitch. The default setting is 0-5V/potentiometer.

When wiring multiple TP boards together, follow the guidelines in the Wiring Multiple TP boards section.

Any leg of the command input can tolerate shorts to the (0V) input. Connecting the 24V power to the command input will cause damage to the unit.

4.3.1 Input Fail-safe Protection

If the signal sent to the TP boards command input should become electrically open the control output will be forced to an off or less than 5% output power state.

4.4 Cycle Times

The TP has 4 available cycle times of 200mS, 1S, 10S, and 100S.

Generally the cycle time should be chosen based on the mass of the load to be controlled; the larger the load mass, the longer the cycle time can be. Generally, it is best to choose the longest cycle time that can be used without causing process ripple.

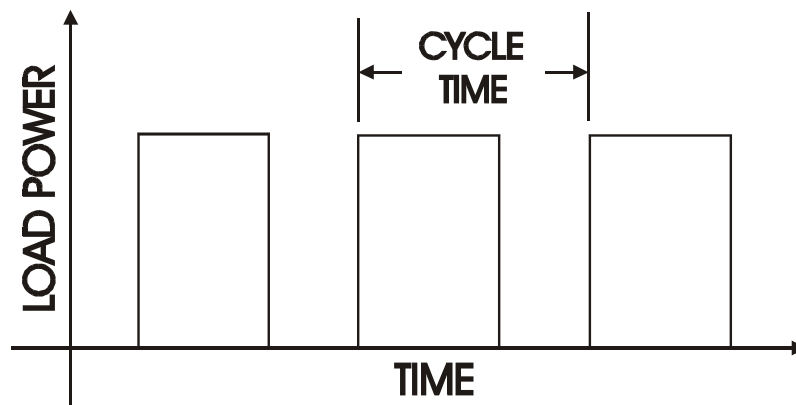

4.5 Power Limit

The Power Limit option can be ordered as TP-PL. The Power Limit feature is used to limit the average power delivered to the load. The power limit is adjustable via a potentiometer located just below the input terminal block. The Power limit feature is only available for use with 24VAC Power.

4.5.1 Power Limit Adjustment Procedure

The Power Limit is adjustable from 5% to 100% of the max load power (0-100% for 1-5V or 4-20mA ranges). Setting the Power Limit potentiometer half way corresponds to a power limit of approximately 55%. With the command input set to approximately 100% (on startup) turn the pot fully CCW. Then just turn the pot CW until the desired output power is achieved.

4.6 Configuration Dipswitch

The configuration dipswitch is used for setting up the command input, and the cycle time. Using a pen point gently push the switch up for on and down for off according to the setup outlined in the table below.

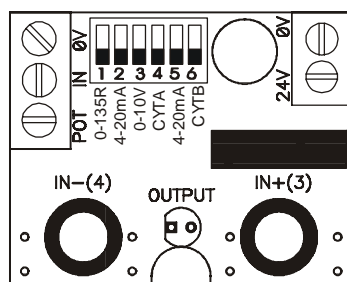

Command Input	1	2	3	5
0-5V (Default)	OFF	OFF	OFF	OFF
Potentiometer	OFF	OFF	OFF	OFF
0-10V	OFF	OFF	ON	OFF
4-20mA	OFF	ON	OFF	ON
1-5V	OFF	OFF	OFF	ON
2-10V	OFF	OFF	ON	ON
0-135Ω*	ON	OFF	OFF	OFF

*Module must be ordered as TP-135 for 0-135Ω input support.
135 Ω input support is only useable with 24VAC Power.

Cycle Time	4	6
200mS	OFF	OFF
1 Second	OFF	ON
10 Seconds	ON	OFF
100 Seconds	ON	ON

4.7 Control Output

The TP SSR output drive is a DC pulsed current limited drive signal of 10V/15mA (24VAC power) or 10V/9.5mA (24VDC power). This is more than enough current for driving most 3-32V standard SSRs, however it is still important to review the data sheet for the SSR you would like to use for compatibility with the TP's output drive. The control output can tolerate a momentary direct short. The following graph will allow you to verify the SSR's compatibility with the TP over wide input voltage variations.

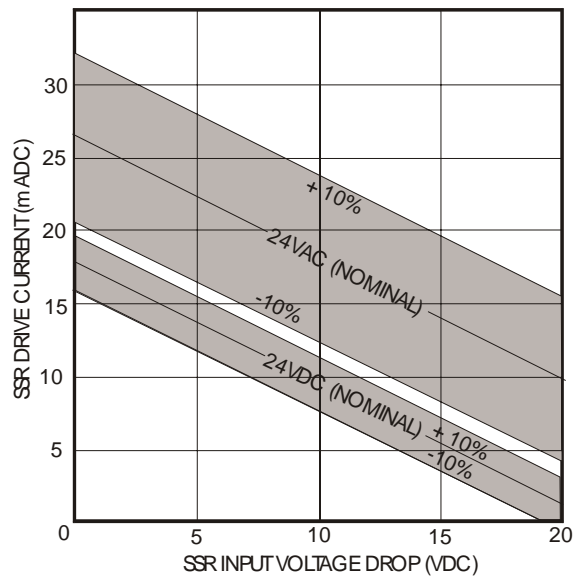

TP Output Drive Current vs. SSR Input Voltage Drop

4.8 Output LED

The TP's RED output LED will turn on when the output is on. The output LED is wired in series with the SSRs input. If there is a poor connection on the SSR input terminals or a problem with the SSRs Input, the output LED will not become energized.

4.9 Three Phase Operation

One TP can be used to control two poles of a three phase load using two SSRs with their control inputs wired in parallel. The Module should be wired as shown in the three phase wiring diagrams sections. The Control Output section should be reviewed to make sure that the total input current requirements of the two SSRs can be achieved with the TP.

4.9.1 Three Phase Operation – Cycle Times

When using the TP to control three phase loads, the cycle time should be set for at least one second and preferably 10 or 100 seconds. This will maximize the control resolution and minimize any load imbalances.

4.10 Wiring Multiple Units

If more than one TP is to be used from a non-isolated or common command signals:

1. A common power transformer can be shared. If the input selected is 0-10V or 0-5V, the inputs should be wired in parallel.
2. If multiple units must be powered from one power transformer and 4-20mA input is selected, one module should be set for 4-20mA and the remaining modules should be set for 1-5V.
3. If the command is 4-20mA, and the command inputs are to be wired in series, a separate power transformer for each module is required to isolate the inputs.

4.10.1 Connecting Power & Commands In Parallel

When multiple TP power inputs and commands are wired in parallel, all of the 0V terminals must be connected together follows:

Power:	Command:
0V----0V----0V---->	0V----0V----0V---->
24V---24V---24V--->	IN-----IN-----IN----->

No crossing of the power input feed or command signal is permitted. If for some reason the power should become crossed, it will cause a direct short in the system. If properly fused, the fuse will blow and the TP will not be damaged. If the command inputs are wired improperly, damage to TP can result.

We do not guarantee operation of the TP with any other manufacturer's SSR control module. Using them in the same circuit may cause either module to be damaged.

5. Electrical Specifications

Command Inputs	4-20mA, 0-10V, 0-5V, 0-135 Ω, Pot, 0-135 Ω
Input Impedance	10K Ω (0-10V), 250Ω (4-20mA), 100KΩ (0-5V)
0-135 Ω Excitation Current	13mA max
Control Output	SSR Drive, nominally 10V at 15mA (24VAC) 10V at 9.5mA (24VDC)
Output Resolution	0.5% for 4-20mA, 0-5V, pot and 0-10V. 1% for 0-135 Ω
Output Linearity	1.5% for 4-20mA, 0-5V, pot and 0-10V. 5% for 0-135 Ω
Power Limit Range	5-100% of max load power.
External Potentiometer Res.	10KΩ-25KΩ
Ambient Temperature Range	0 to 70 °C
Power Supply	24VAC +15/-15%, 24VDC +30%/-10%
Power consumption	Less than 2 Watts

6. Mechanical Dimensions

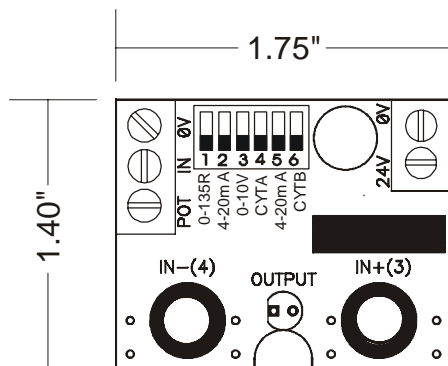

Max Height is 0.6"

7. Contact Information

HBControls, Inc
 221 Weaver St
 Fall River, MA
 02720
www.HBControls.com
 (800) 879-7918

8. WIRING DIAGRAM (4-20mA, 0-5V, 0-10V Inputs)

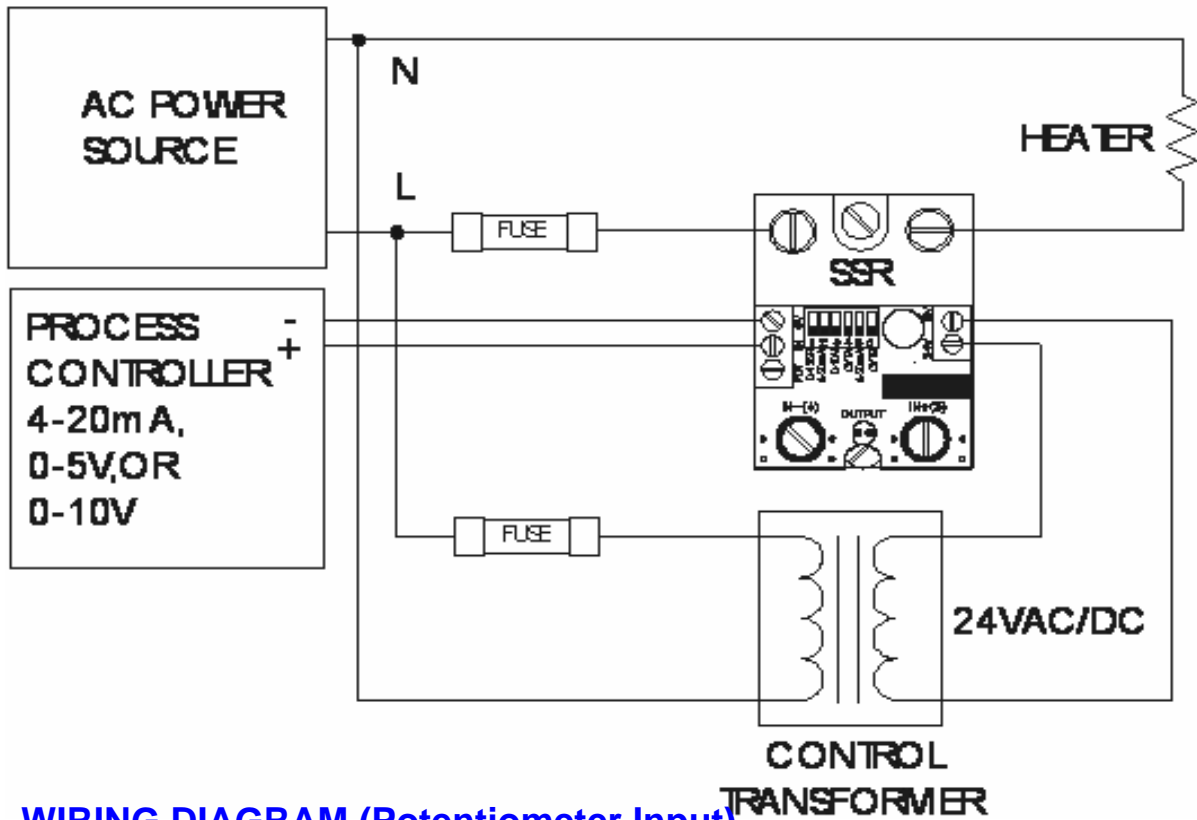

9. WIRING DIAGRAM (Potentiometer Input)

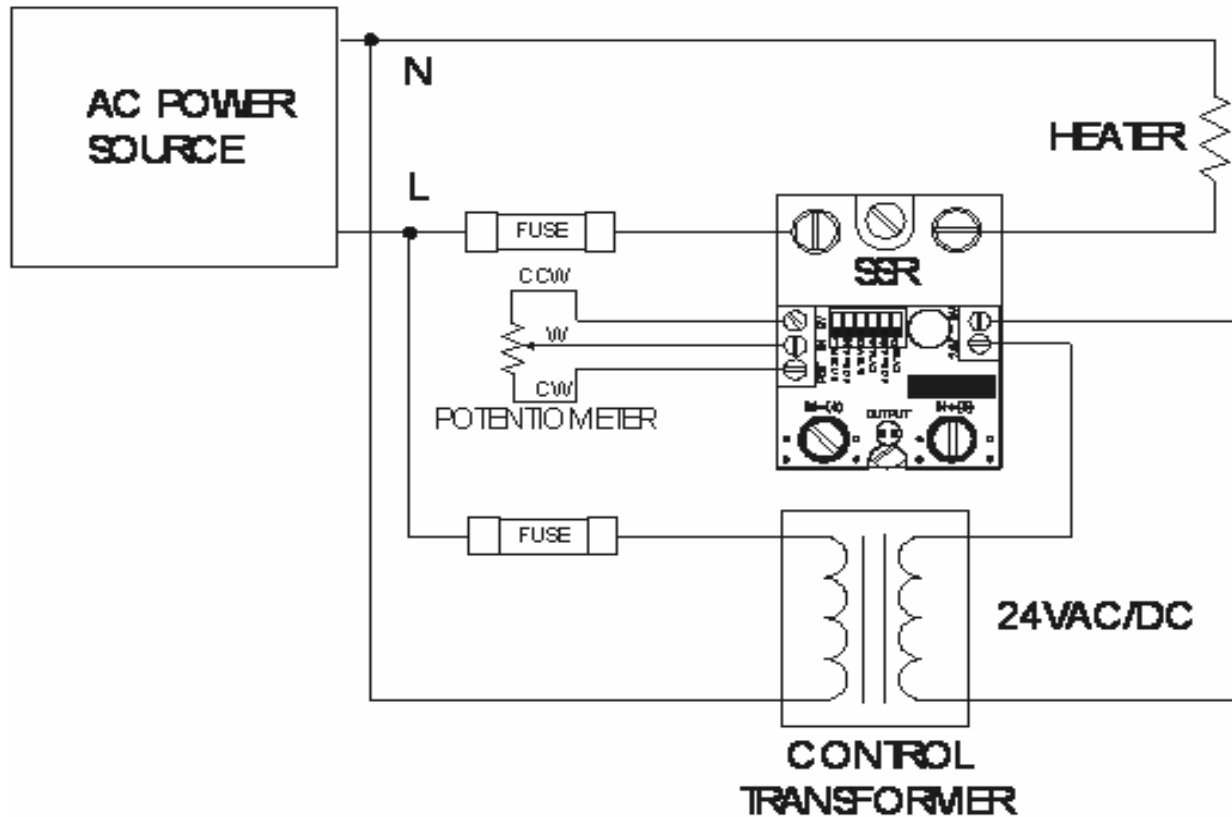

10. WIRING DIAGRAM (0-135 Ohm Input)

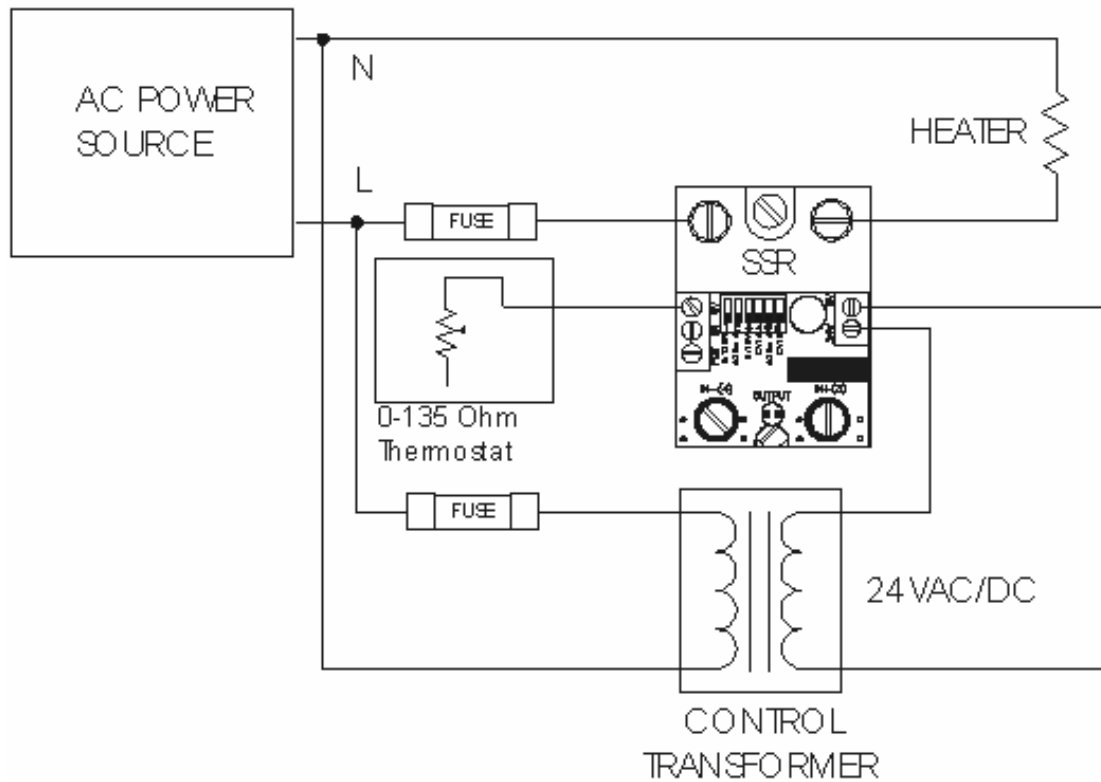

11. WIRING DIAGRAM 3 PHASE DELTA CONNECTION

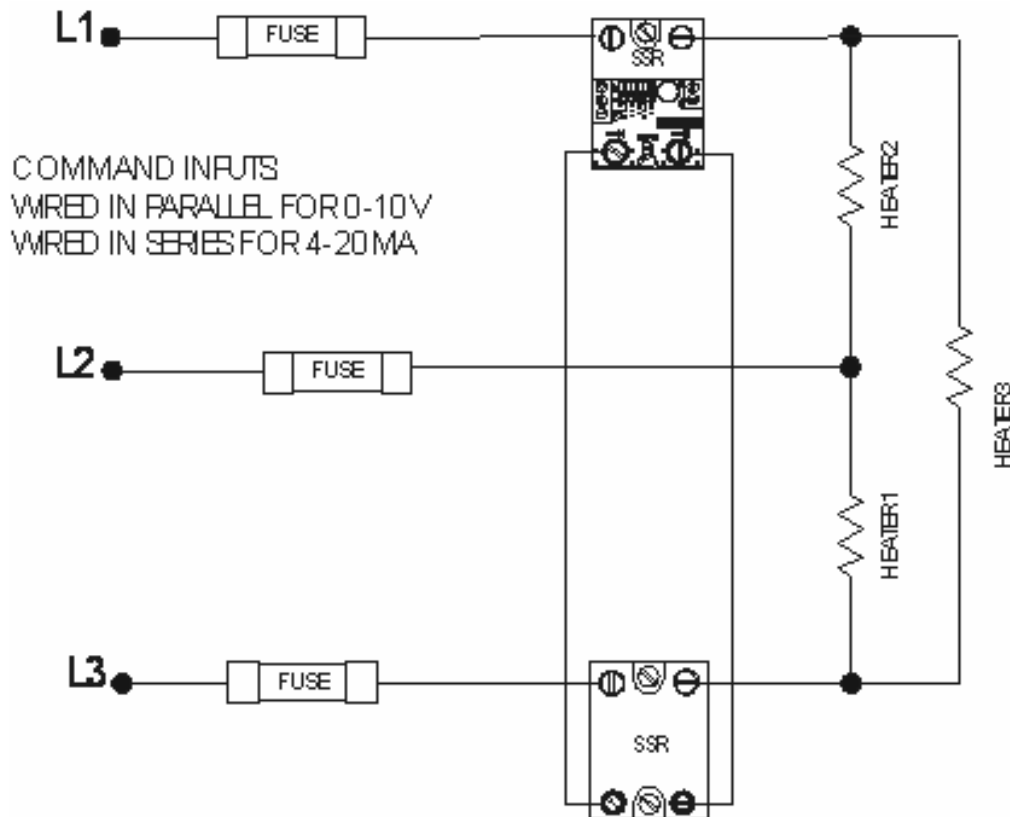

12. WIRING DIAGRAM 3 PHASE WYE

